







Montageanleitung für Sitzbank

SIGNAL

- 4 x  10 x 40 C31
- 6 x  T10
- 6 x  C33
- 6 x  T11
- 1 x  4 mm T12

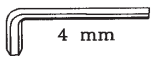
Benötigte Werkzeuge

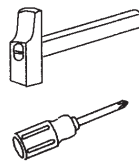

Benötigte Personen

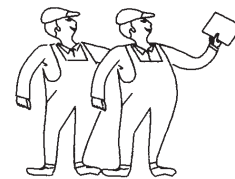

1

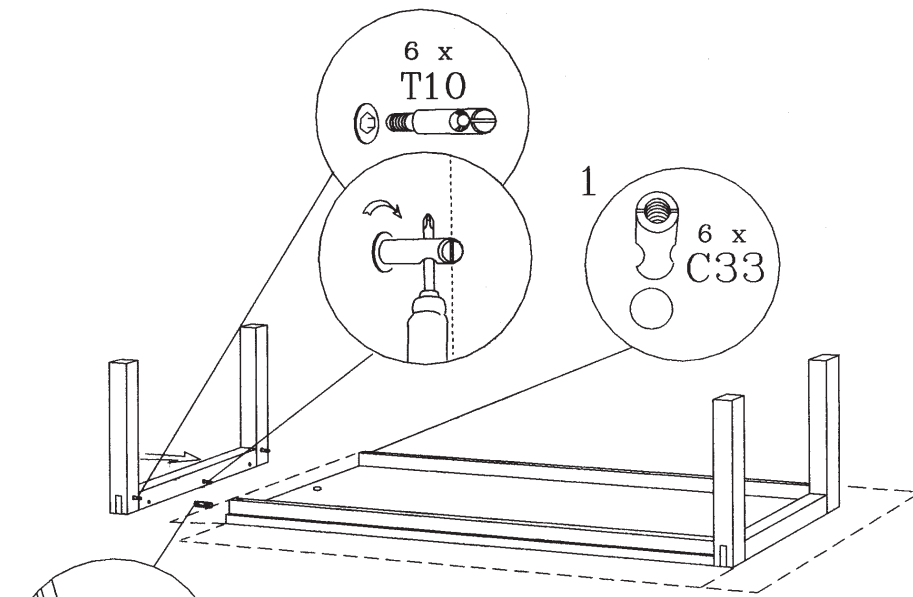



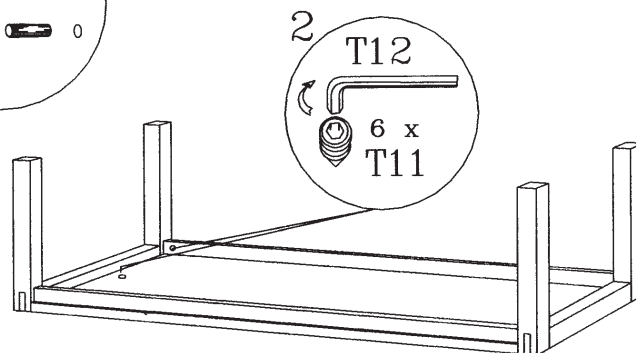

2



Montageanleitung für Sitzbank

SIGNAL

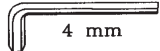
- 4 x  10 x 40 C31
- 6 x  T10
- 6 x  C33
- 6 x  T11
- 1 x  4 mm T12

Benötigte Werkzeuge Benötigte Personen

