

1

26.02.2013



**Service • Assistenza • Dienstverlening • Serwis
Servis • Szerviz • Сервисная служба**

Name • Nom • Nome • Naam
Nazwa • Jméno • Názov • Név
Denumire • Ísim • Название

Nr. • No. • N° • Номер • Č • Sz

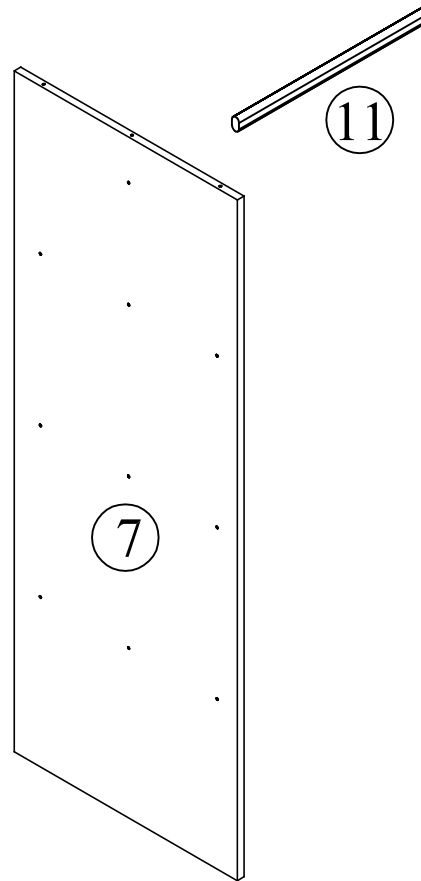
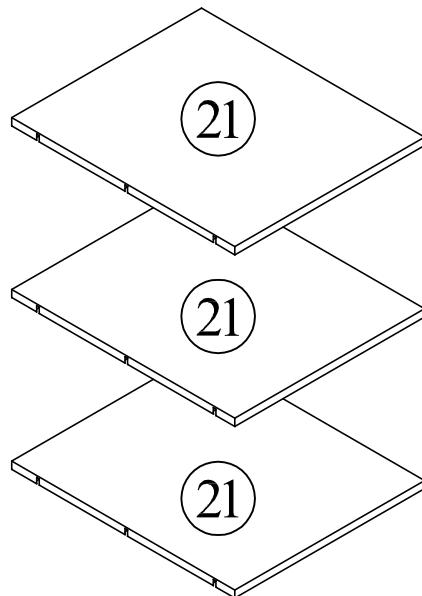
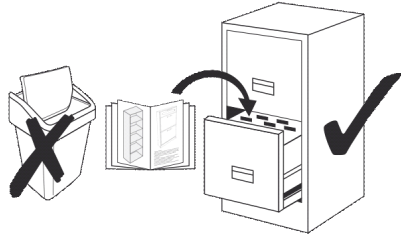
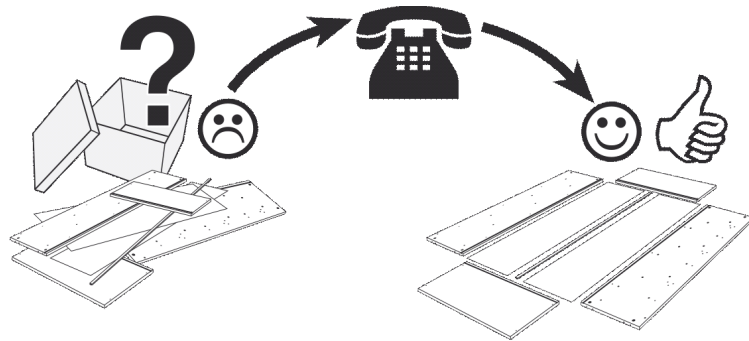
Typ • Type • Tip • Típus • Тіро
Тип

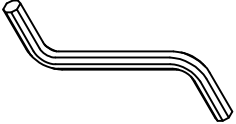
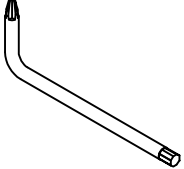

F1  x18	B2  x18	B5  x6 <small>Ø7x50</small>
I2  x1	I1  x1	

